









PRODUCT SPECIFICATIONS

MAXI WASTE SWIVEL SYSTEM

FLEXI FIN - ROUND



ID	 DIAMETER	 GRATE	 SUIT	
DWV	100x100	Chrome	DWV	20

ID	 DIAMETER	 GRATE	 SUIT	
HDPE/Cu	110x110	Chrome	HDPE/Cu 20	

RELATED PRODUCTS

- Square also available, please contact Plastec for more information.

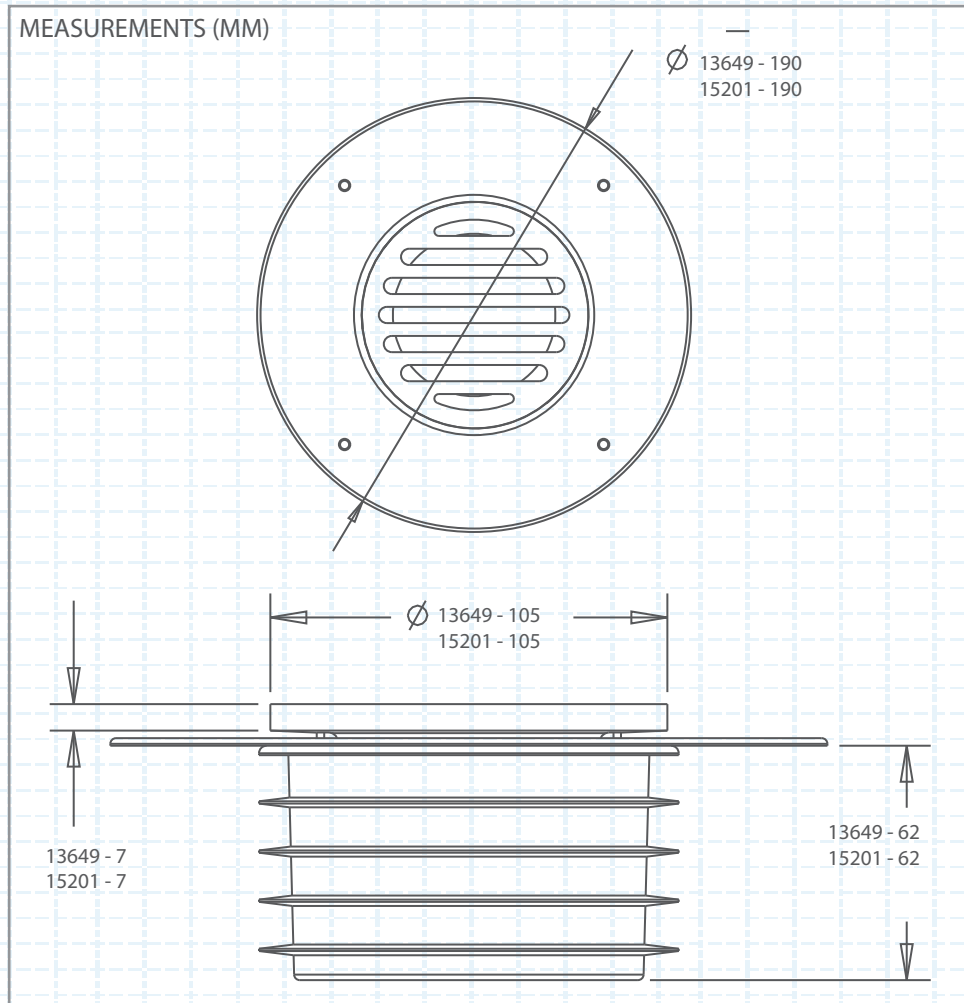

WaterMark
ATS5200.040

PH: 07 5413 4444 WWW.PLASTEC.COM.AU

DETAILS CORRECT AS AT 15/01/2021, BUT IS SUBJECT TO CHANGE WITHOUT NOTICE

 DIAMETER  FASTENING  BAG QTY  CARTON QTY  FINISH/COLOUR  MEASUREMENT (MM)